

Echodis+

The Core of our Water Management Platform

Static Water Meter combines last end ultrasonic measurement technology with high performing radio frequency and MBus open communication to help Water Utilities in revenue protection. With no moving parts, the Static Water Meter allows for protection against unplanned maintenance costs and provides accurate measurement over the entire product life. Integrated AMI & AMR offers the benefits of tailored functionalities within mobile or fixed collection systems. Pulse output is also available for dedicated customer system.

FEATURES AND BENEFITS

- » High metrology accuracy & repeatability
- » Low pressure drop
- » No metering of air
- » Insensitive to sand or other particles in water
- » IP68, extractable battery
- » Battery life time up to 15 years
- » AMI & AMR embedded and standard wireless MBus protocol
- » Water temperature measurement

Technology

- » High end static technology for revenue protection
 - Highly accurate measurement of consumption, temperature, leakage analysis, air detection...

- Long lifetime to decrease maintenance costs
- Resistant to network accidents
- » Monitoring intelligence
 - Water Management efficiency
 - Flow profile, backflow and tampering alarms, all thresholds programmable, abnormal consumptions...
- » Installation
 - Any position
 - IP 68 permanent immersion (acc.EN60529)
 - Direct sunlight exposure
 - Tamper resistant thanks to integrated construction & insensitive to magnetic fields

Communication

- » Integrated radio and MBus technology for mobile or fixed network collection systems (AMI & AMR)
- » Bi-directional Pulse output
- » Inductive communication for metrology verification
- » Optical pulse output for automatic test bench verification

Approval and standards

- » MID, 2014/32/EU and 2014/53/EU Directive
- » International Standard ISO 4064:2017
- » OIML R49 2013
- » Compliance to potable drinking water (ACS, KTW, WRAS,... certification)
- » ROHS 2 2011/65/UE



ENVIRONMENTAL-ECO DESIGN

Itron has adopted an eco-design approach. Ecodesign consists of taking the environmental impact of a product into account, over its whole lifecycle and in relation to various environmental aspects, while maintaining its functionality.

The Static Water Meter is designed to provide a more environmental friendly product. A life cycle assessment study has been carried out to meet this challenge.

The recycling process has been optimised by creating a product that is easy to dismantle into separate components (batteries, PCB, brass...).

MULTIFUNCTIONAL DISPLAY

- » Easy to read display
- » Visual alarms
- » Configurable display sequence



Static Water Meter LCD display

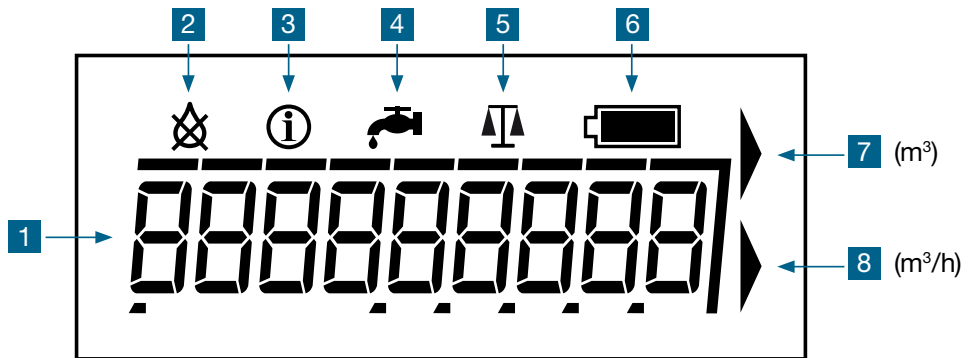

- | | | |
|---|---|---|
| <p>1 Main display 8/9 digits</p> <ul style="list-style-type: none"> - Index - Flowrate - Alarm - ... | <p>2 Air in pipe indicator</p> <p>3 System or application Alarm indicator</p> <p>4 Leakage indicator</p> <p>5 Test mode indicator Recalibration indicator</p> | <p>6 Battery level indicator</p> <p>7 Volume unit indicator
(Blinking when flowrate detected)</p> <p>8 Flowrate unit indicator</p> |
|---|---|---|

COMMUNICATION

Radio Frequency Features	
Protocol	RADIAN
Modulation	Frequency Shift Keying
Frequency carrier	433.82 MHz
Radiated power	≤ 10 mW
Transmission	Symmetrical 2-way communication
Line of sight reading distance (LOS)	> 1500m

Static Water Meter integrates Itron Radio Technology.

This opens up to a large range of advanced and reliable AMR systems:

- » Radio walk-by systems
- » Radio fixed data collection systems

Automatic radio meter reading increases the reading reliability and significantly enhances the data acquisition speed.

The radio reading also opens accessibility to all meters even if the customer is absent or in hard to read locations.

Wireless M-Bus according to EN 13757-3 & 4	
Operation mode	T1/C1/T2/C2
Frequency band	Compliant OMS Annex 0, PHY-A/PHY-B 434,75/868,95MHz
Duty cycle	1%
Chiprate	Typ. 100 kcps
Encryption	AES 128, Mode 5

Pulse	
Electrical characteristics	Open collector
Pulse weight (standard)	1 liter/pulse*
OFF-State max Ext. Voltage	60 VDC
ON-State max. Sink current	100 mA
Pulse width (ON-State)	65 ms*

*configurable in production

3 wires with direction or cable cut detection:

- 1 - Pulse
- 2 - Ground
- 3 - DIR or Cable cut

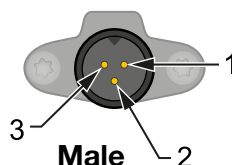

M-Bus Features	
Compliant with	EN 13757
Baud rate	300 to 2400 bps
Cable	2 wires, non polarized cable

Echodis+ is AMI M-bus pre-equipped. This opens up to a large range of advanced and reliable AMI systems:

- » Walk-by systems
- » Fixed data collection systems

Key Advantages

- » Itron standard meter interface
- » No need of additional investments on the water meter
- » Electronic detection principle (no wear or bounce)
- » Leak detection
- » Reverse flow detection
- » Fraud detection
- » Not sensitive to magnetic fields

For further info, refer to the specific leaflet.

Technical Specifications

Nominal Diameter DN	mm inches	15 1/2"	20 3/4"	25 1"	32 1 1/4"	40 1 1/2"	50 2"				
In compliance with MID - (2014/32/EU)											
MID Accuracy Ratio (Q3/Q1) all positions		160 / 250	160 / 400	160 / 400	160 / 630	160 / 630	160 / 800	160 / 800	160 / 400	160 / 400*	
MID type Approval Number		LNE 25269									
Nominal Flow Rate (Q3)	m³/h	1.6	2.5	2.5	4	6.3	10	10	16	25	
Standard Production Ratio** (Q3/Q1)		250	400	400	400	400	400	400	400	400	
Minimum Flow Rate (Q1)	l/h	6.4	6.25	6.25	10	15.75	25	25	40	62.5	
Transitional Flow Rate (Q2)	l/h	10	10	10	16	25.2	40	40	64	100	
Overload Flow Rate (Q4)	m³/h	2	3.125	3.125	5	7.9	12.5	12.5	20	31.25	
Pressure Loss Class at Q3	bar	0.1	0.25	0.25	0.63	0.4	0.63	0.63	0.4	0.63	
Maximum Admissible Pressure	MAP bar	16									
Sensitivity Class		U0D0									
Water Operating Temperature T	°C	0.1 / 70									
Climatic Environment	°C	-25 / 70									

* R630 at T 50°C - ** Other Ratios available under specific request

Other Characteristics

Indication Range*	m³	99999.999								999999.999	9999999.99
Minimum Scale Interval**	l	1								10	10
Typical Starting Flow Rate	l/h	2	2	2	2	6	6	6	15	15	
Testing Pressure	bar	25									
Maximum Accidental Water Temperature	°C	80 (<1h/week)									

* Comma configurable under specific request - ** 0.01 liter in test mode

TYPICAL ACCURACY CURVE Q3=2,5 M³/H

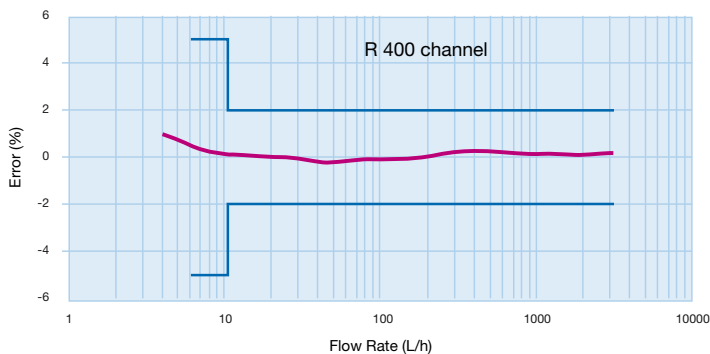

HEAD LOSS

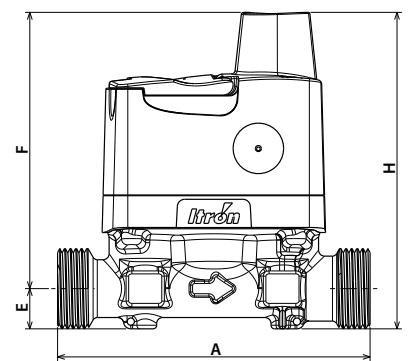
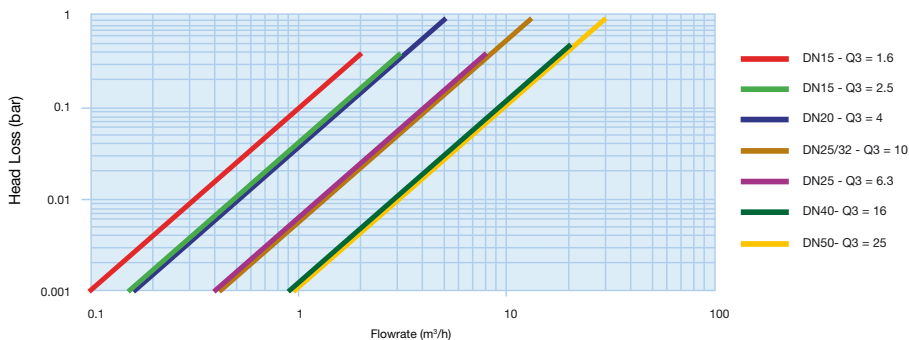

DIMENSIONS

Nominal Diameter	mm	15	20	25	32	40	50
A	mm	110 - 165* - 170*	130 - 190*	260	260	300	300
G	inches	G 3/4 B	G 1 B	G1 1/4 B	G1 1/2 B	G2 B	G2 1/2 B
B	mm	93					
C	mm	93					
D	mm	46.5					
E	mm	17	17	25.4	25.4	33	37.6
F	mm	115	115	117	117	125	125
F (wMBus, Pulse Encoder)	mm	96	96	98.6	98.6	106.5	106.5
H	mm	132	132	142.4	142.4	158	162.5
H (wMBus, Pulse Encoder)	mm	113	113	124	124	139.5	144.1
Weight	Kg	1	1.3	1.9	2	2.4	2.5

* Pulse version on demand

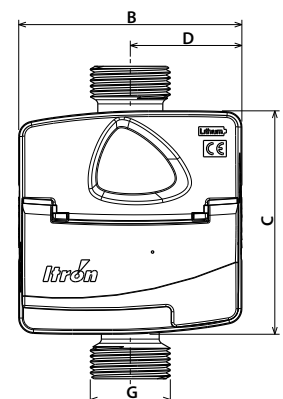

ENHANCED FUNCTIONALITIES (AMR/AMI)

	Index	Records total volume of water consumed
	Instantaneous flow rate	Measures current flow rate over the last minute
	Air in pipe	Air is detected, meter stops counting
	Backflow	Total volume measured under back flow is recorded
	Broken pipe	Flow rate reaches abnormal flow rate for a minimum time
	Flow repartition	Real flow rate is recorded according to operational segments
	Leakage	Flow rate never goes under a minimum value Number of days with leakage is stored
	Battery alarm	Product battery is ending
	Peak flow	Record 5 highest flow rates
	Minimum flow	Record 5 lowest flow rates
	Peak temperature	Record 5 highest Water Temperature
	Alarm water temperature	Configuration of low and High temperature alarms
	Time synchronization	Walk by / Drive by: Meter clock re-synch at every read Fixed network : daily automatic clock re-synchronization
	Volume below threshold	Total consumption below a low flow-rate threshold
	Volume above threshold	Total consumption above a high flow-rate threshold
	Time of use	Registers consumption within defined intervals of the year
	Logging intervals**	Record consumption hour/day/week/month intervals 54, 108, 216 intervals configurable storage
	Reversed meter	Alarm if > 1000l in reverse flow have been recorded
	Meter stopped	Alarm if no consumption has been recorded over a configurable period
	Fraud	When someone tries to open the meter
	Custom billing period	Stores volume index at 4 preset dates
	Alarm reconfiguration*	Stores events of reconfiguration of a meter via radio
	Event log	Last critical alarms are recorded date stamped

*Except for MBus version

** Only 108 hourly data for wireless M-Bus version



Intelis MBus



Intelis RF



Intelis wMBus



Intelis Pulse Encoder



Join us in creating a more **resourceful world**.
To learn more visit **itron.com**

While Itron strives to make the content of its marketing materials as timely and accurate as possible, Itron makes no claims, promises, or guarantees about the accuracy, completeness, or adequacy of, and expressly disclaims liability for errors and omissions in, such materials. No warranty of any kind, implied, expressed, or statutory, including but not limited to the warranties of non-infringement of third party rights, title, merchantability, and fitness for a particular purpose, is given with respect to the content of these marketing materials. © Copyright 2021 Itron. All rights reserved. **WA-0102.12-EN-06.21**

ITRON WATER METERING

9, rue Ampère
71031 Mâcon cedex
France

Phone: +33 3 85 29 39 00
Fax: +33 3 85 29 38 58